

SHARE

Technology • Connections • Results

8471 - Making System z the Center of Enterprise Computing

Presented By: Mark Neft

Accenture – Application Modernization & Optimization Strategy Lead

Mark.neft@accenture.com

March 2, 2011

Session 8471



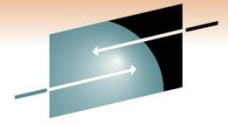

SHARE
Technology • Connections • Results

Presentation Abstract:

- How to exploit the best aspects of z/OS and Enterprise Virtualization to create a cost effective and highly reliable application Eco System. The presentation will use real examples of combining z/OS and Linux on System z to create a cost effective and highly reliable enterprise solution. This includes leveraging DB2 with zIIP engines, and Java, COBOL and Oracle RAC all running on Linux on System z, to create a simplified and scalable solutions. I will also highlight some of the cost savings models illustrating how this solution reduced Oracle software cost by over 80% and mainframe costs by 30% or more.
- Learn how to enable z/OS workload to run on Linux for System z
- Review case studies of Oracle and COBOL application running on System z

Objectives

- Review the value proposition of the System z in enterprise computing
 - What is Mainframe Optimization
 - What are the options on the mainframe
 - Uber- virtualization
 - Oracle super scaling
 - Enabling COBOL - z/OS workload to run on Linux for System z
 - The mainframe is not dead and neither is COBOL

Mainframe Optimization (MFO)

- MFO is an approach that positions the best of System Z across z/OS to enable Linux on System z and now zBX
- Why is it important today?
 - Typically the Mainframe is the single largest line-item on an IT budget
 - IT budgets are getting reduced by 10% - 50%
 - The mainframe is the logical place to start
- How to reduce costs by 20%-80% without leaving the mainframe

There are five key aspects to Mainframe Optimization:



1. Understanding your baseline costs
2. Server Consolidation – “Uber-virtualization” of distributed platform to System z / Linux
3. Oracle Consolidation – Consolidate multiply Oracle instances onto a smaller foot print and reduce the number of Oracle licenses
4. Fit for Purpose workload – run the right work load on the right parts of the System z
5. When to upgrade the mainframe

Mainframe Optimization

Prioritizing the work and measuring the benefits during the journey

- Accommodate changes in business imperatives
- Proactively understand the affects of the different levers within portfolio
- Measure and monitor the progress – focus on the quantifiable results

Continuously prioritize the portfolio

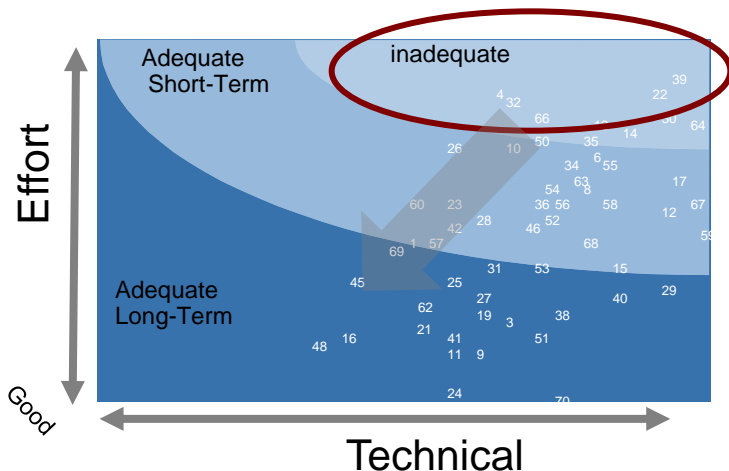

Show the progress using a business view

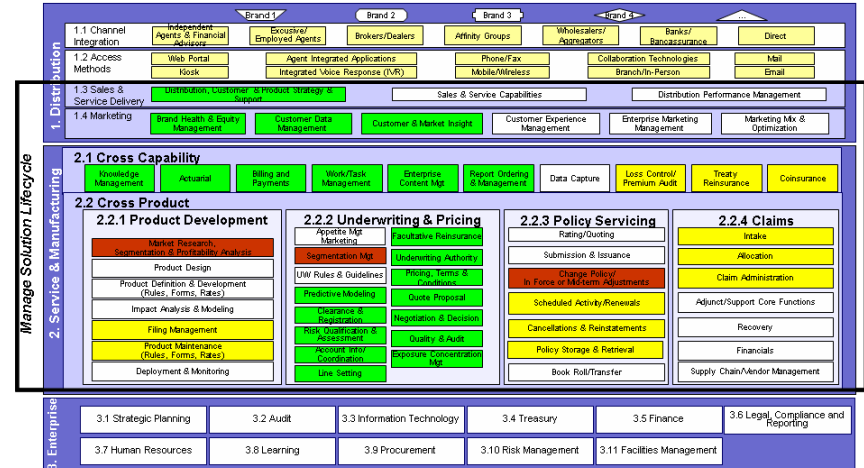

Business focus view showing the results kept IT aligned with the changing business imperatives

Illustrative Key of Complexity:

Orange = High
Blue = Normal

Yellow = Medium
Others = not in scope

Server Consolidation

- Running the Organization on a Box

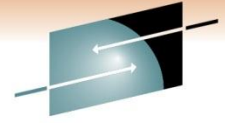

SHARE
Technology • Connections • Results

- Levering the tried and true LPAR technologies enables organization to exploit cost effective, scalable, and stable Open Source deployment
 - The ability to co-locate tightly coupled solutions
 - The ability to optimize hardware during functional consolidation
 - The ability to prioritize (share) hardware to meet business needs now (Dev/Test/Prod)

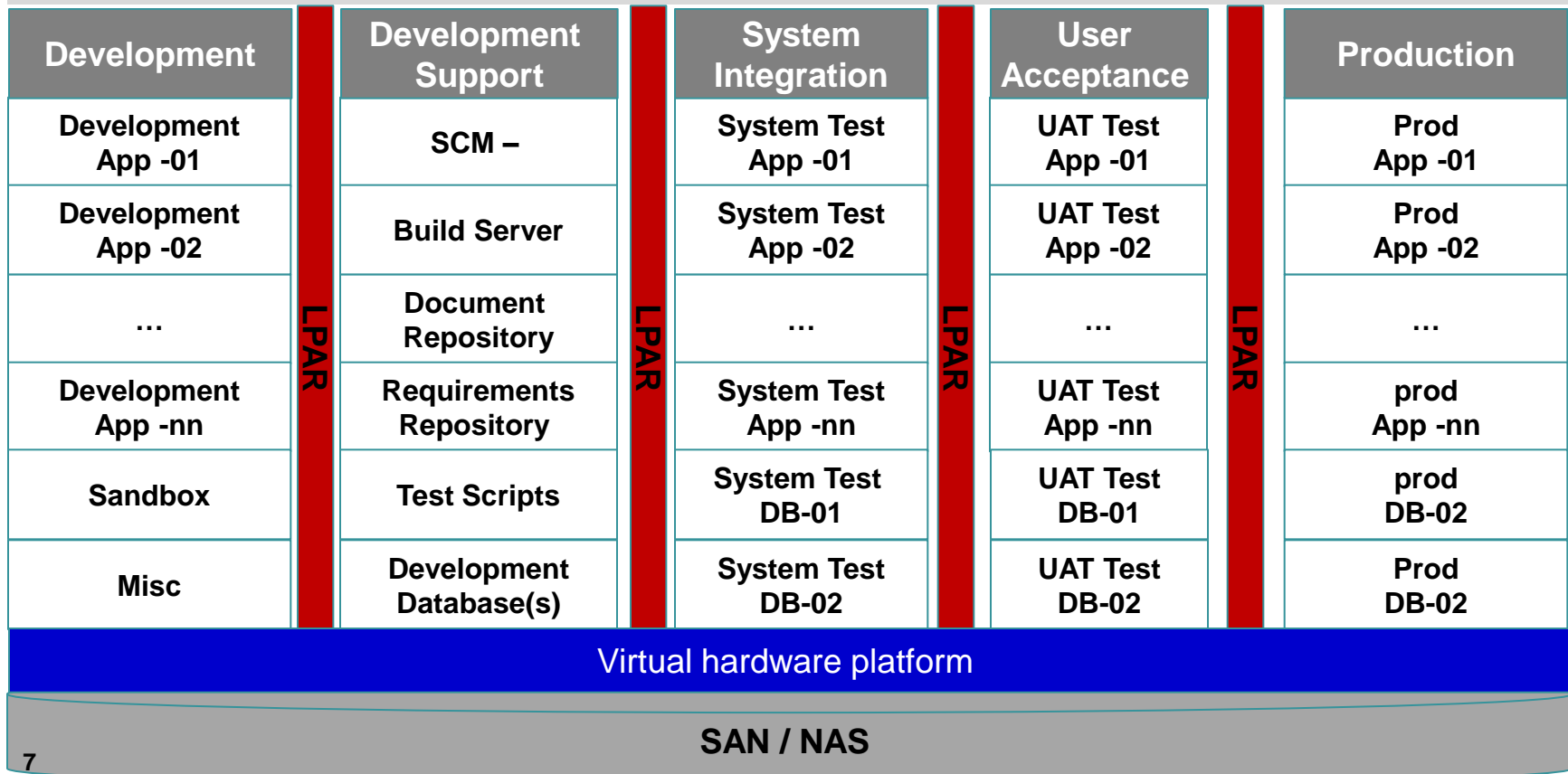



Value Proposition: Oracle Consolidation

Global Company

- Achieve super scalability on a small footprint
- Oracle software costs reduced by 85%*
- Physical footprint reduced by 80% (3 Racks vs. 15 racks)**
- Background
 - 2 Node OracleRac Cluster
 - >36TB
 - Single tables of 3+ Billion rows
 - Full primary and foreign keys
 - Indexes
 - Referential Integrity turned on
- Results Achieved
 - Over 7 hours the application averaged >240,000 TPS
 - Multi-row inserts / updates
 - CPU utilization was ~50% on the Oracle server
 - Application is Java running on the IFL as well

* Oracle would have required 224 Intel processors to support the same load or 4 node Superdome plus equivalent hardware for just production DR

** excluding Disk

Oracle

- Achieve Super Scalability on a Small Footprint

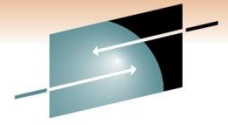

SHARE
Technology • Connections • Results

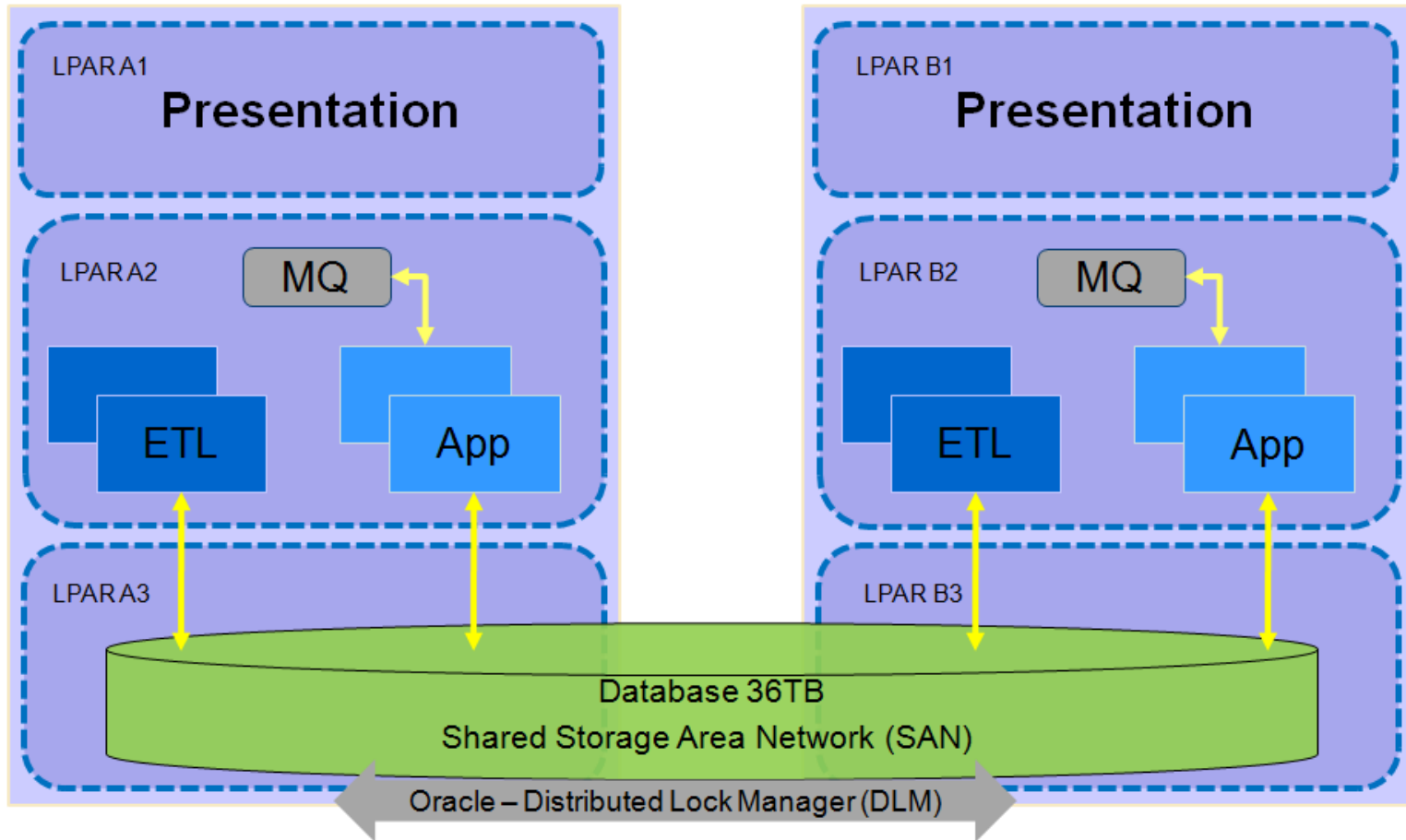

Savings Delivered in the First Year



SHARE
Technology • Connections • Results

Value Proposition: Fit for Purpose workloads

Small Application Footprint

A small application currently costing \$1.5M/year to operate becomes \$0.1M or a five year savings of over \$6M (Including the cost of migration)

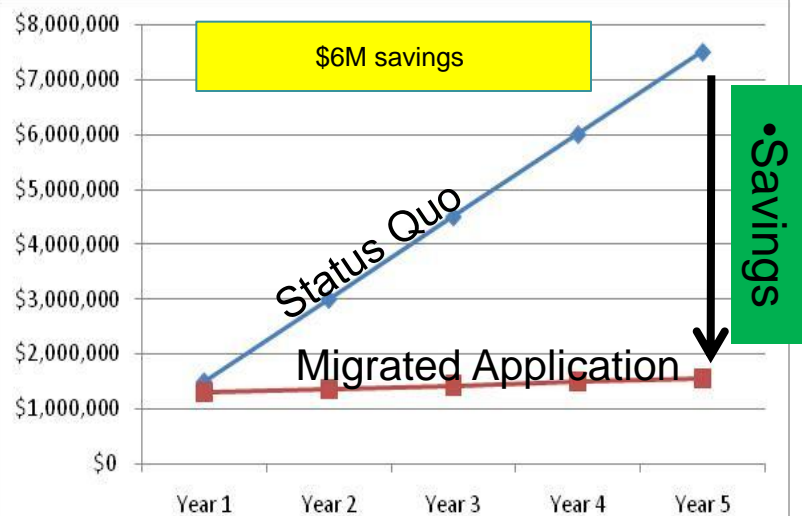

Illustrative cost comparisons:

Example 1:
z/OS \$XX/CPU Hour vs IFL \$Y.Y/YCPU Hour

Partial Application Deployment*

Moving a portion of a 5,000 MIP application to an IFL allows a cost reduction of \$40-55M and a cost avoidance savings of \$70-\$90M

* Patent Pending

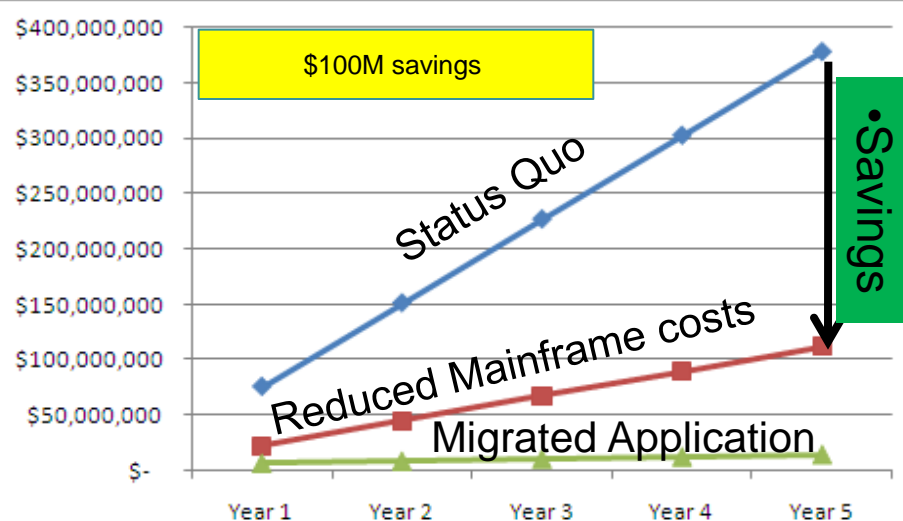

Illustrative cost comparisons:

Example 2:
z/OS engine \$ XXX vs. IFL engine XXX / 90
Comparable Intel server required 5-10 more or 2-3x

Simple Workload Classifications

- **Batch**
 - File based
 - Database
 - Message Based (MQ)
- **Online / Real-Time**
 - Screen Based (3270)
 - Message based (MQ)
 - Services based (SOAP)
- **Heavy CPU**
 - Compute intensive
 - Complex calculations
 - Sort
- **Heavy I/O**
 - Large I/O
 - Chatty with the database
 - Conversational

Question to answer – what makes up peak MIPS

Fit for Purpose Batch Workload

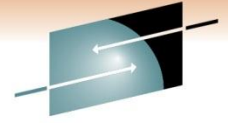

SHARE
Technology • Connections • Results

- Current Batch job runs on z/OS
- Step 02 use 90% of the CPU
- Using a new tools – a single step can be shifted to the IFL where the CPU intensive is more cost effective to run (BLUEACCEL)

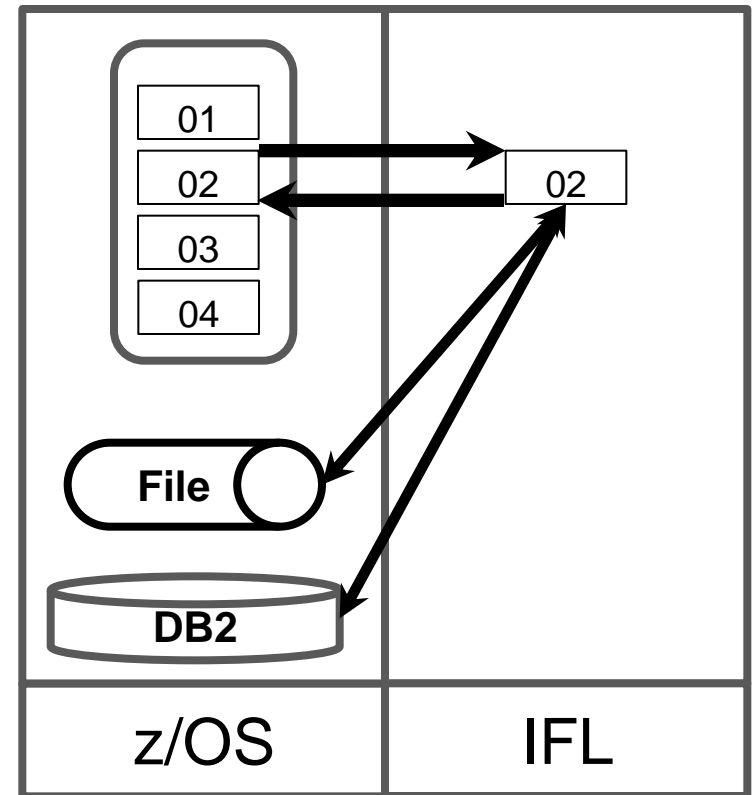

Mainframe Application Configuration Typical

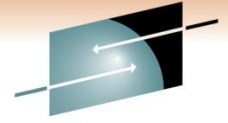

SHARE
Technology • Connections • Results

Mainframe

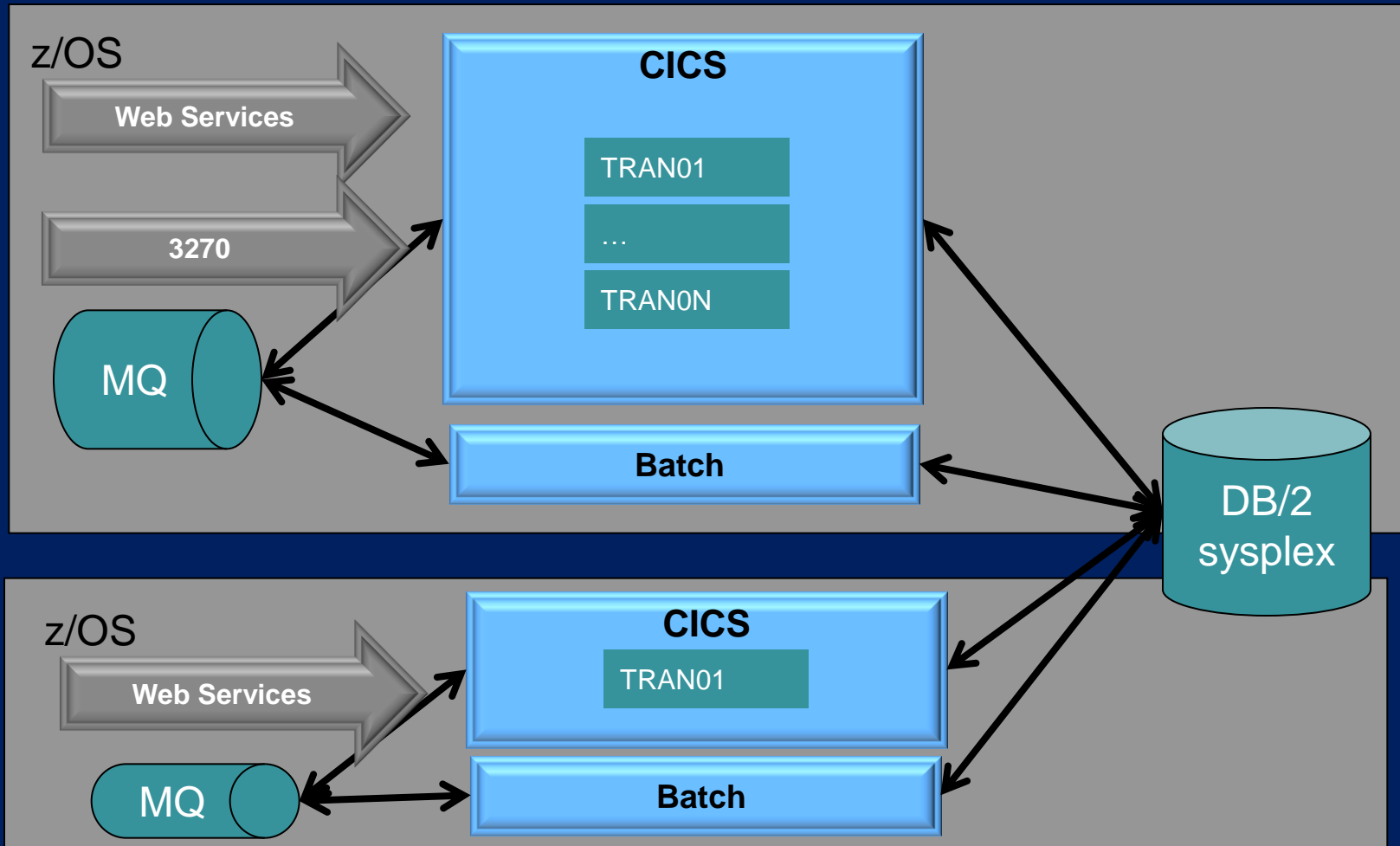

Mainframe Application Configuration Coexistence with the IFL

Mainframe

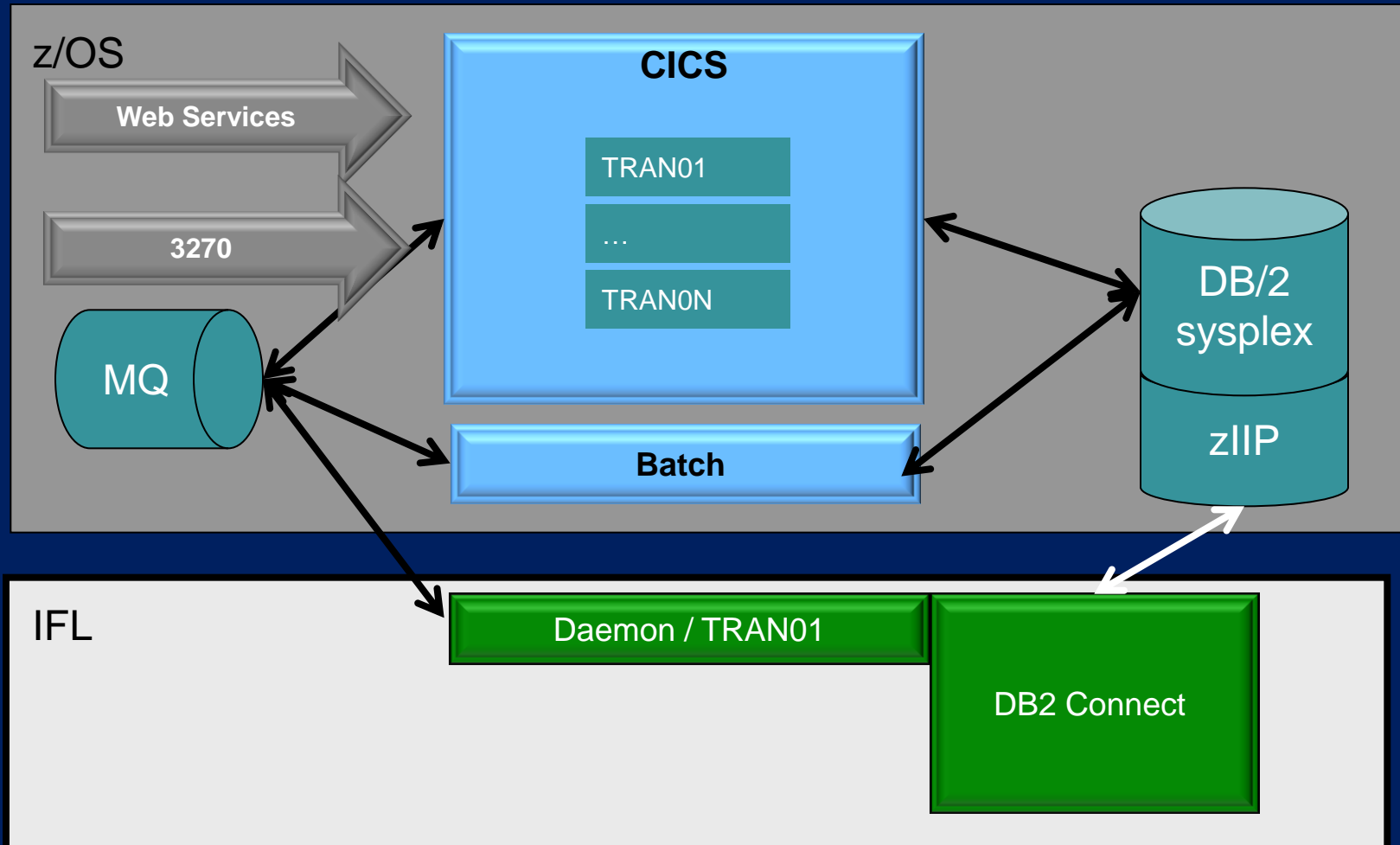

Mainframe Application Configuration Coexistence with the IFL

Mainframe

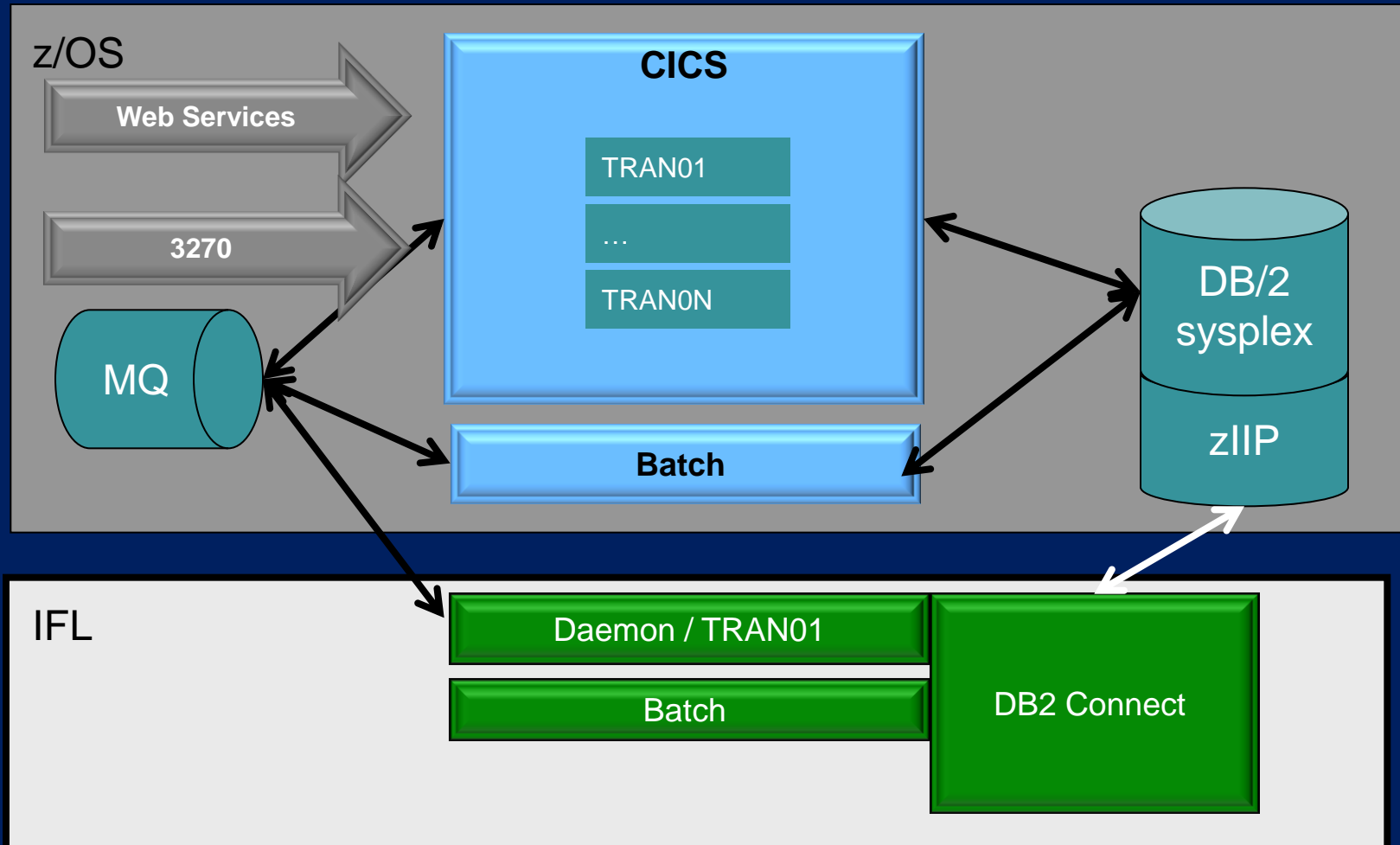

Mainframe Application Configuration Coexistence with the IFL

Mainframe

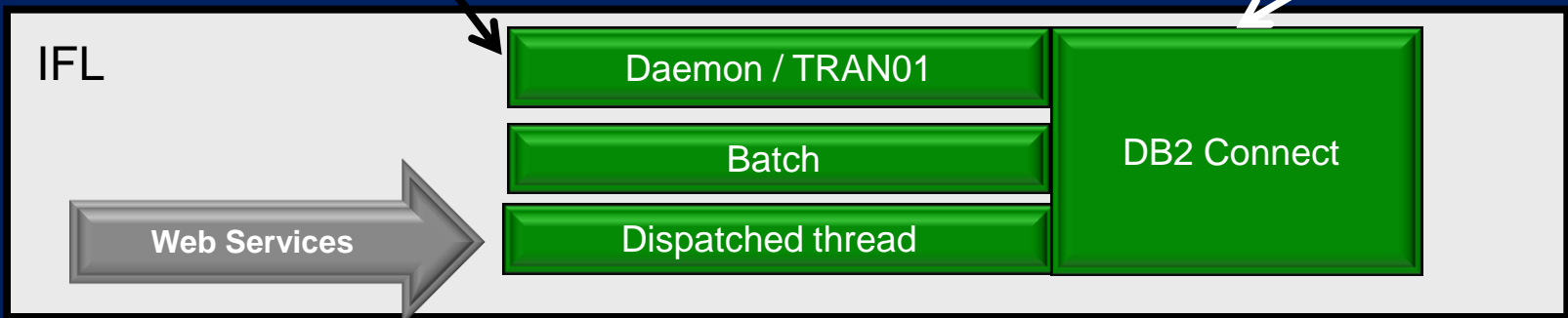
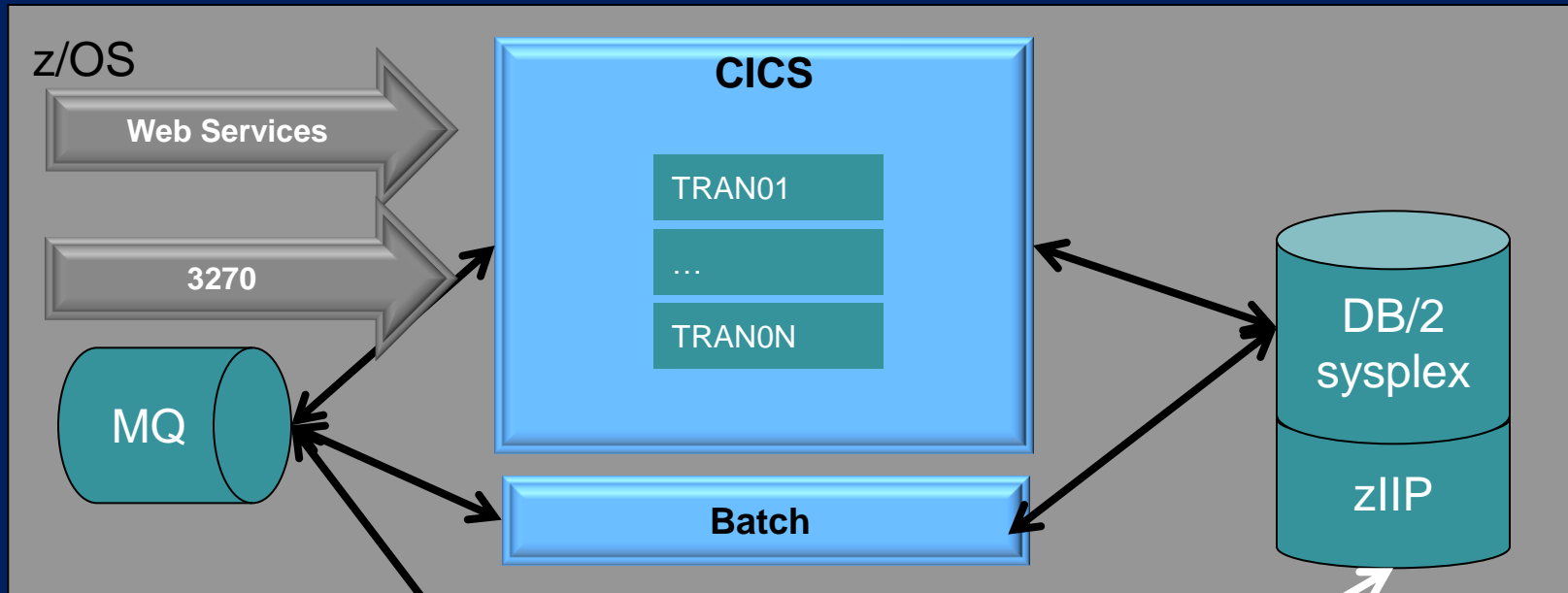

Mainframe Application Configuration Coexistence with the IFL

Mainframe

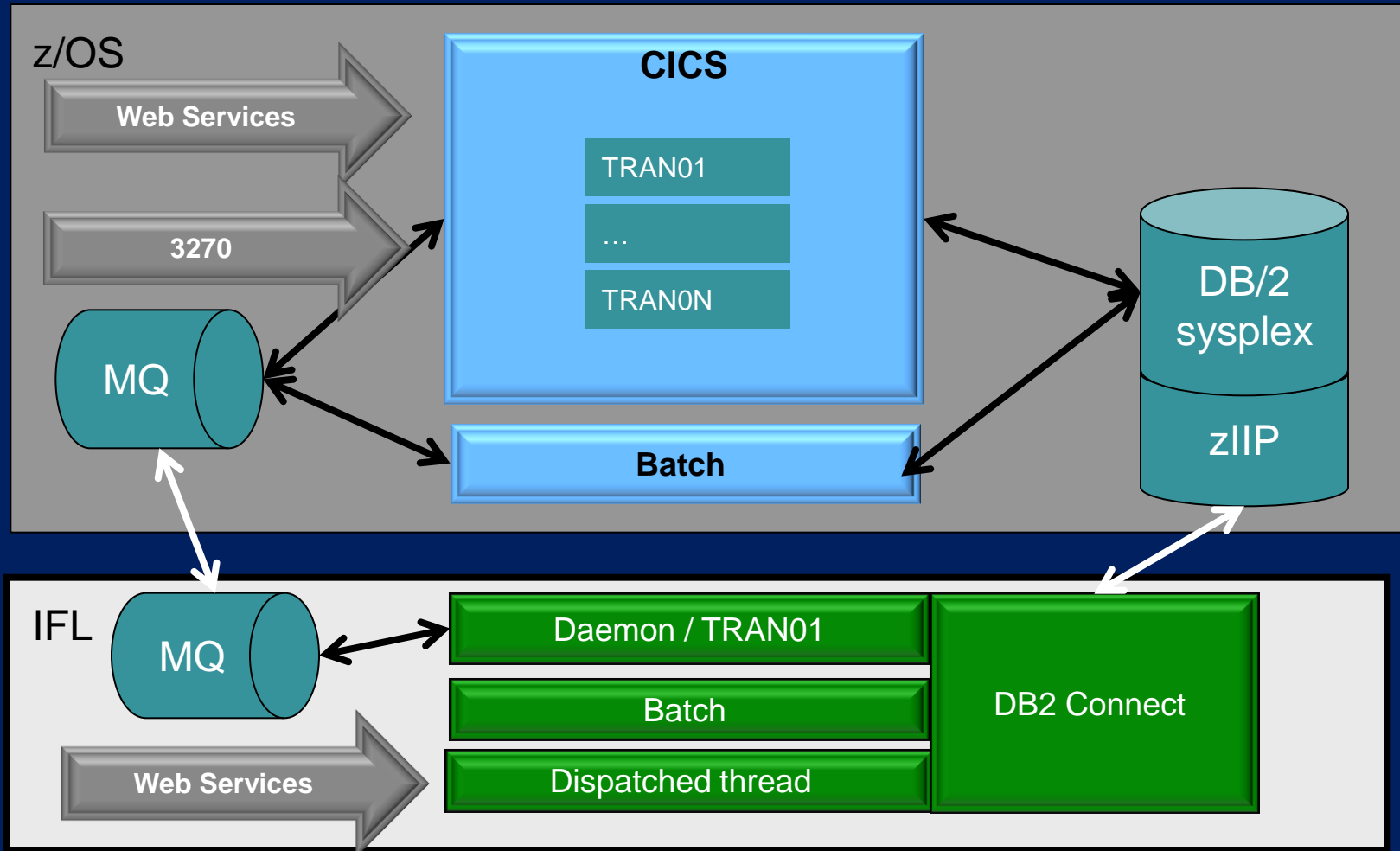

Mainframe Application Configuration Coexistence with the IFL

Mainframe

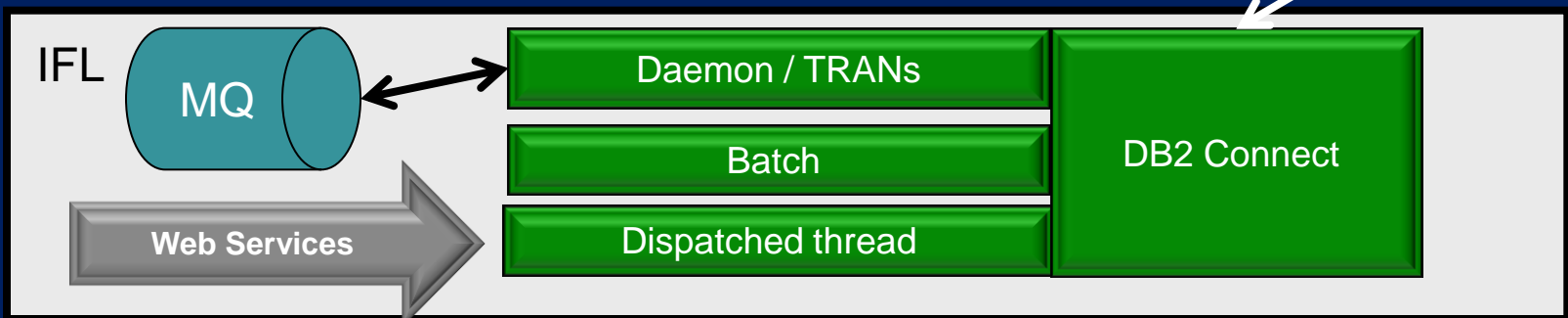

Mainframe Application Configuration Coexistence with the IFL

Mainframe

z/OS

Let z/OS enable Linux on System z to be a safe place for Mission Critical Enterprise Applications

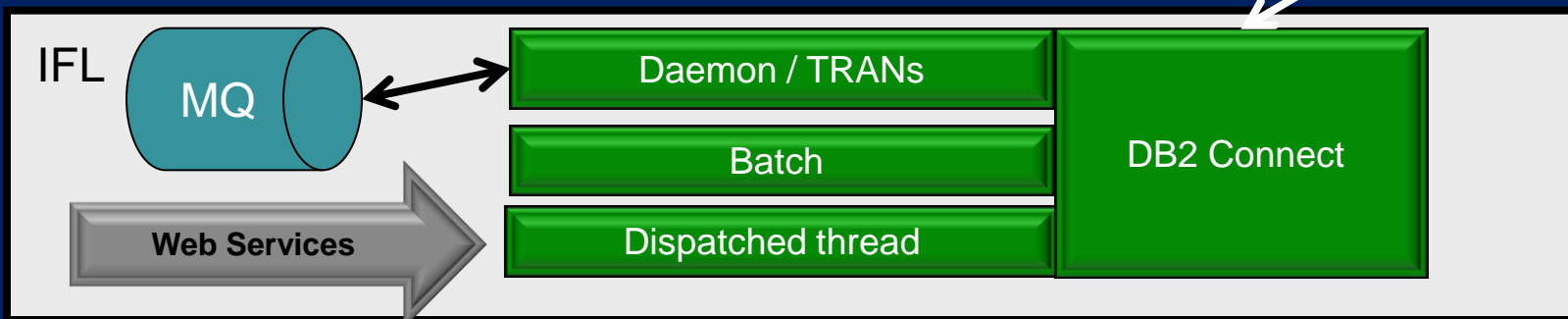
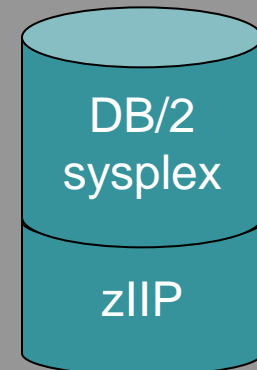

Fit for Purpose – Utilization Summary

Volume doubles during the migration



Phase 2 Migration

- May 2010
- System continues to Run hot

CP Processor Utilization by Hour																								
Processor/Hour	00	01	02	03	04	05	06	07	08	09	10	11	12	13	14	15	16	17	18	19	20	21	22	23
	%	%	%	%	%	%	%	%	%	%	%	%	%	%	%	%	%	%	%	%	%	%	%	%
ALPHA																								
2010/05/28-FRI	59	64	63	62	57	58	60	66	73	81	80	88	82	85	81	86	92	91	73	72	55	63	58	58
2010/05/27-THU	63	60	67	53	52	52	60	85	83	74	82	78	72	81	74	85	92	84	67	62	63	58	58	56
2010/05/26-WED	66	68	69	53	48	58	45	56	75	79	81	85	83	89	81	84	78	79	59	67	63	62	67	61
2010/05/25-TUE	65	61	62	51	47	44	51	62	61	60	63	61	61	73	72	80	81	81	76	74	60	62	55	51
2010/05/24-MON	45	58	62	53	49	50	49	52	56	64	65	67	63	74	73	78	87	81	81	70	61	57	52	41
2010/05/23-SUN	85	61	49	47	50	34	32	35	35	34	30	20	62	71	60	45	36	33	28	31	32	37	33	38
2010/05/22-SAT	69	95	65	65	68	66	63	68	72	74	72	74	64	53	50	49	51	45	50	44	41	40	39	76
ALPHA Average Mon-Fri	60	62	65	54	51	52	53	64	70	72	74	76	72	80	76	83	86	83	71	69	60	60	58	53
ZETA																								
2010/05/28-FRI	97	85	79	65	79	82	81	83	87	94	96	97	97	97	90	95	94	89	94	85	92	95	86	82
2010/05/27-THU	91	85	80	60	61	59	68	68	85	91	88	95	90	94	96	95	97	96	88	85	71	77	77	87
2010/05/26-WED	90	87	88	68	68	79	62	76	89	93	94	99	89	95	93	94	90	91	84	88	93	99	85	68
2010/05/25-TUE	93	95	84	82	77	70	80	83	95	96	91	89	82	92	93	92	96	96	97	85	81	86	89	76
2010/05/24-MON	79	81	78	74	60	67	65	73	89	95	95	95	97	98	97	96	98	96	97	93	86	90	90	72
2010/05/23-SUN	93	94	79	84	75	59	60	37	40	39	35	24	60	-	-	-	-	-	-	39	92	79	58	56
2010/05/22-SAT	92	100	100	95	91	85	88	93	92	94	96	95	93	93	85	84	89	81	75	77	88	77	74	89
ZETA Average Mon-Fri	90	87	82	70	69	71	71	77	89	94	93	95	91	95	94	94	95	94	92	87	85	89	85	77

70%

90%

Phase 3 Migration

- Nov 2010
- Volume doubled
- System Running at 50% Capacity

CP Processor Utilization by Hour																								
Processor/Hour	00	01	02	03	04	05	06	07	08	09	10	11	12	13	14	15	16	17	18	19	20	21	22	23
	%	%	%	%	%	%	%	%	%	%	%	%	%	%	%	%	%	%	%	%	%	%	%	%
ALPHA																								
2010/11/15-MON	51	63	50	35	32	38	25	26	32	38	43	38	36	35	39	43	32	34	33	54	47	42	35	40
2010/11/14-SUN	97	85	44	29	25	16	14	15	20	14	14	14	66	46	21	21	17	23	18	19	30	29	29	32
2010/11/13-SAT	61	89	88	66	50	51	50	45	45	41	41	39	36	35	36	31	28	23	32	46	40	32	65	
2010/11/12-FRI	57	50	36	38	44	51	35	39	44	46	52	48	44	49	41	53	44	40	41	48	52	48	38	70
2010/11/11-THU	59	68	48	39	32	45	32	28	35	31	34	34	33	29	30	33	32	33	29	30	42	39	33	35
2010/11/10-WED	63	67	65	53	44	50	36	38	43	60	50	51	44	42	34	49	40	37	38	38	55	45	39	42
2010/11/09-TUE	53	71	73	59	45	48	43	44	38	41	45	41	42	55	49	44	44	48	33	43	63	46	38	40
ALPHA Average Mon-Fri	57	64	54	45	39	46	34	35	38	43	45	42	40	42	39	44	38	38	35	43	52	44	37	45
ZETA																								
2010/11/15-MON	58	67	47	34	34	52	35	37	39	47	50	51	45	45	54	49	40	53	43	68	54	50	48	53
2010/11/14-SUN	95	92	51	43	40	32	20	19	26	25	26	20	80	58	31	29	23	27	25	32	29	36	36	32
2010/11/13-SAT	86	91	90	85	80	54	46	48	49	44	44	60	61	38	41	43	38	46	45	40	37	30	34	66
2010/11/12-FRI	67	47	51	49	47	56	60	52	45	67	54	57	51	54	57	61	51	46	53	51	61	54	53	89
2010/11/11-THU	70	59	54	37	54	43	42	35	35	37	43	35	41	48	46	44	36	40	48	45	45	52	49	43
2010/11/10-WED	69	82	71	57	57	73	49	44	51	53	60	54	47	51	55	69	46	53	49	55	49	52	54	43
2010/11/09-TUE	75	78	80	53	54	61	58	45	56	60	55	59	50	54	58	61	52	49	45	52	46	61	55	61
ZETA Average Mon-Fri	68	67	61	46	49	57	49	43	45	53	52	51	47	50	54	57	45	48	48	54	49	57	50	59

45%

50%

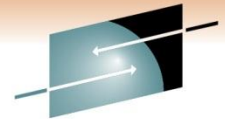

Summary of CICS Workload Migration

- Trans ABC & EFG response time increased from .4s to 12s
- CPU utilization on CECA remained consistent
 - **XYPA** and **XYPC** decreased (**This is good**)
 - **XYOA** and **XYUA** increased (**out of scope workload**)
- CPU Utilization on CECB remained consistent due to growth in XYOB and XYUB (**out of scope workload**)
- CPU Utilization decreased for both CICSONE and BATCHONE work
 - XYPA saw largest decrease (**savings of 1 engine**) ~ 760 MIPS
 - XYPC saw decrease (**saving of .5 engines**) ~ 380 MIPS
 - 1705 QAZ jobs ran on 3/17 - 3525 QAZ jobs ran on 6/3
- CPU Utilization for MQ increased 5-7% on all 4 lpars
- CPU Utilization for DDFPTS increased - transactions doubled
- IFL utilization increased from 15% to 60% (**This is good**)
- ZIIP utilization increased (10% - 20%) (**This is a good**)
- Coupling Facility Utilization remained consistent
 - Requests to QSP0PTSQUEUE1 decreased by 87%

Before

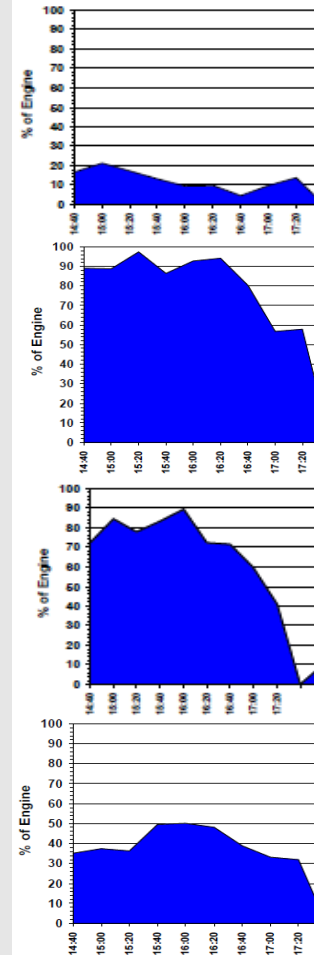

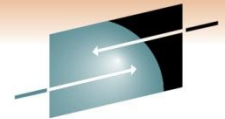

Summary of CICS Workload Migration

- Trans ABC & EFG response time increased from .4s to 12s
- CPU utilization on CECA remained consistent
 - **XYPA and XYPC decreased (This is good)**
 - **XYOA and XYUA increased (out of scope workload)**
- CPU Utilization on CECB remained consistent due to growth in XYOB and XYUB (**out of scope workload**)
- CPU Utilization decreased for both CICSONE and BATCHONE work
 - XYPA saw largest decrease (**savings of 1 engine**) ~ 800 MIPS
 - XYPC saw decrease (**saving of .5 engines**) ~ 400 MIPS
 - 1705 QAZ jobs ran on 3/17 - 3525 QAZ jobs ran on 6/3
- CPU Utilization for MQ increased 5-7% on all 4 lpars
- CPU Utilization for DDFPTS increased - transactions doubled
- IFL utilization increased from 15% to 60% (**This is good**)
- ZIIP utilization increased (10% - 20%) (**This is a good**)
- Coupling Facility Utilization remained consistent
 - Requests to QSP0PTSQUEUES1 decreased by 87%

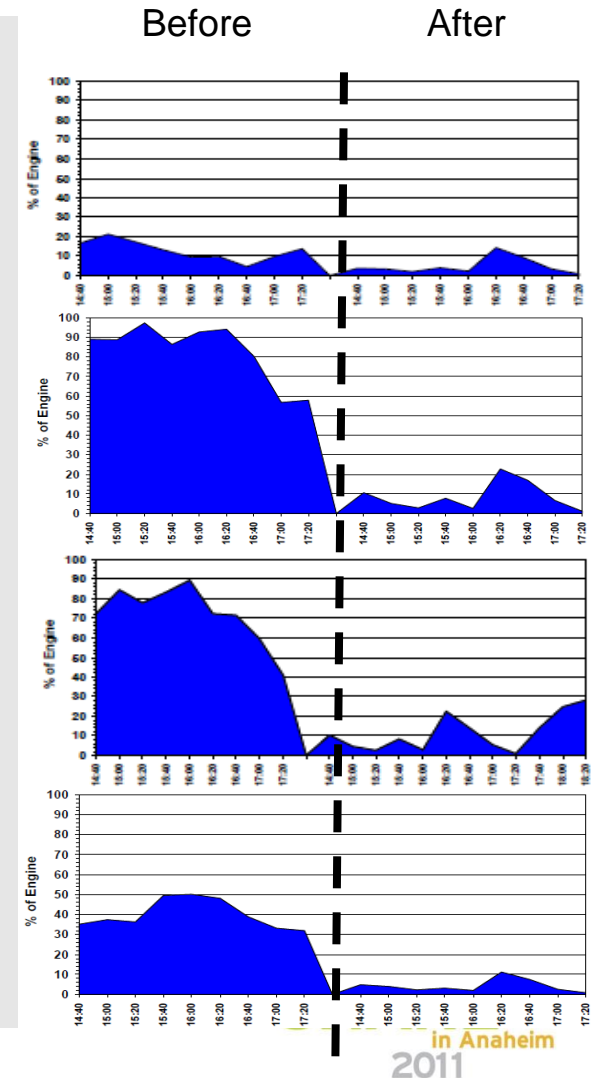

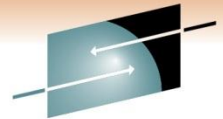

Summary

- Uber - Virtualization on a Small Footprint

- Leverage existing floor space
- Dynamic load balancing
- Development and test can share the same hardware
- No physical network equipment required to connect internal servers
- Internal servers can remain on separate virtual LANS
- Simplified and reduce cost for DR

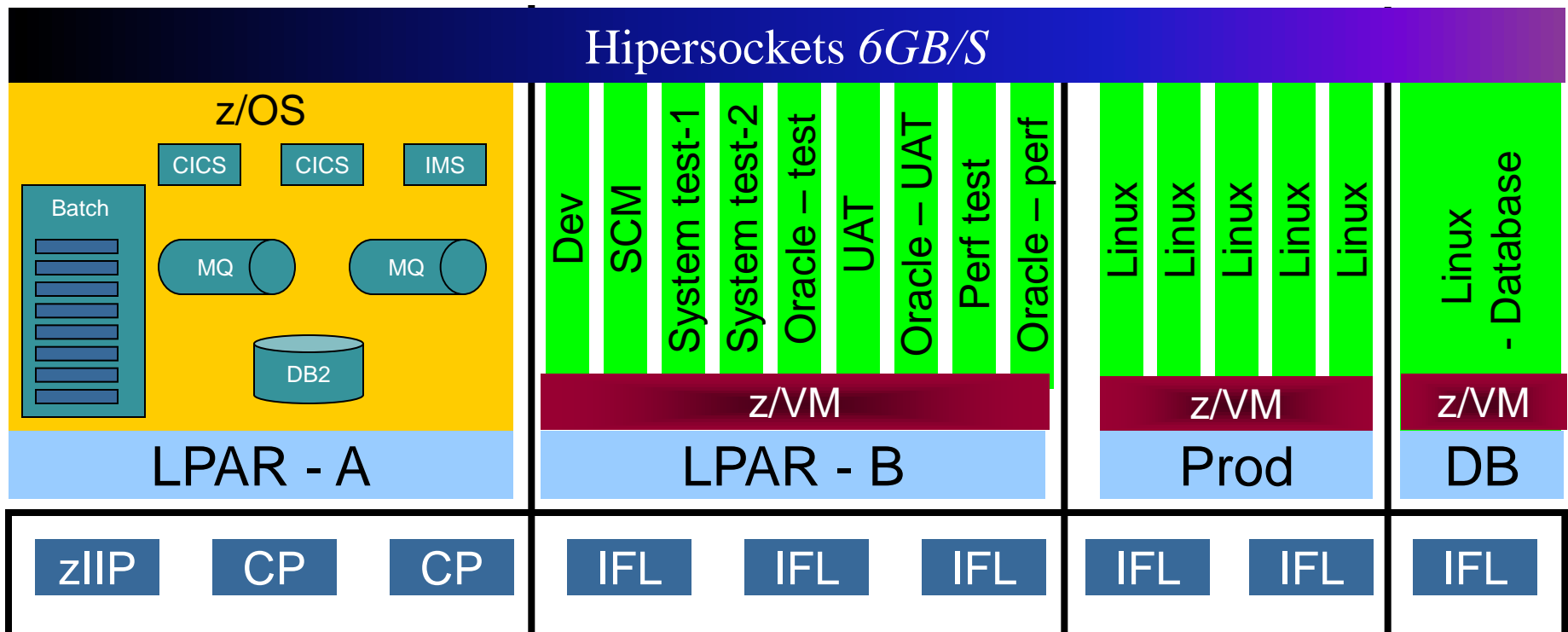

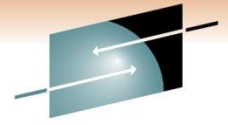

Looking back now

- Having just senior leadership sponsorship is not good enough
- Agree on what the objectives are
 - Reduce COST vs. GP MIPS vs. TOTAL MIPS vs. etc...
- Pick something simple to pilot first
- Understand the current production workload and don't get roped into supporting things that don't happen today

- Other things to consider
 - Change the code on z/OS and validate the same code works in both places
 - Start setting up the operations early
 - Don't be surprised during testing that you find things that really don't work in production today

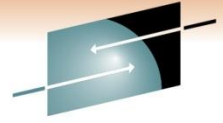

Uber-virtualization everything that works together under one umbrella

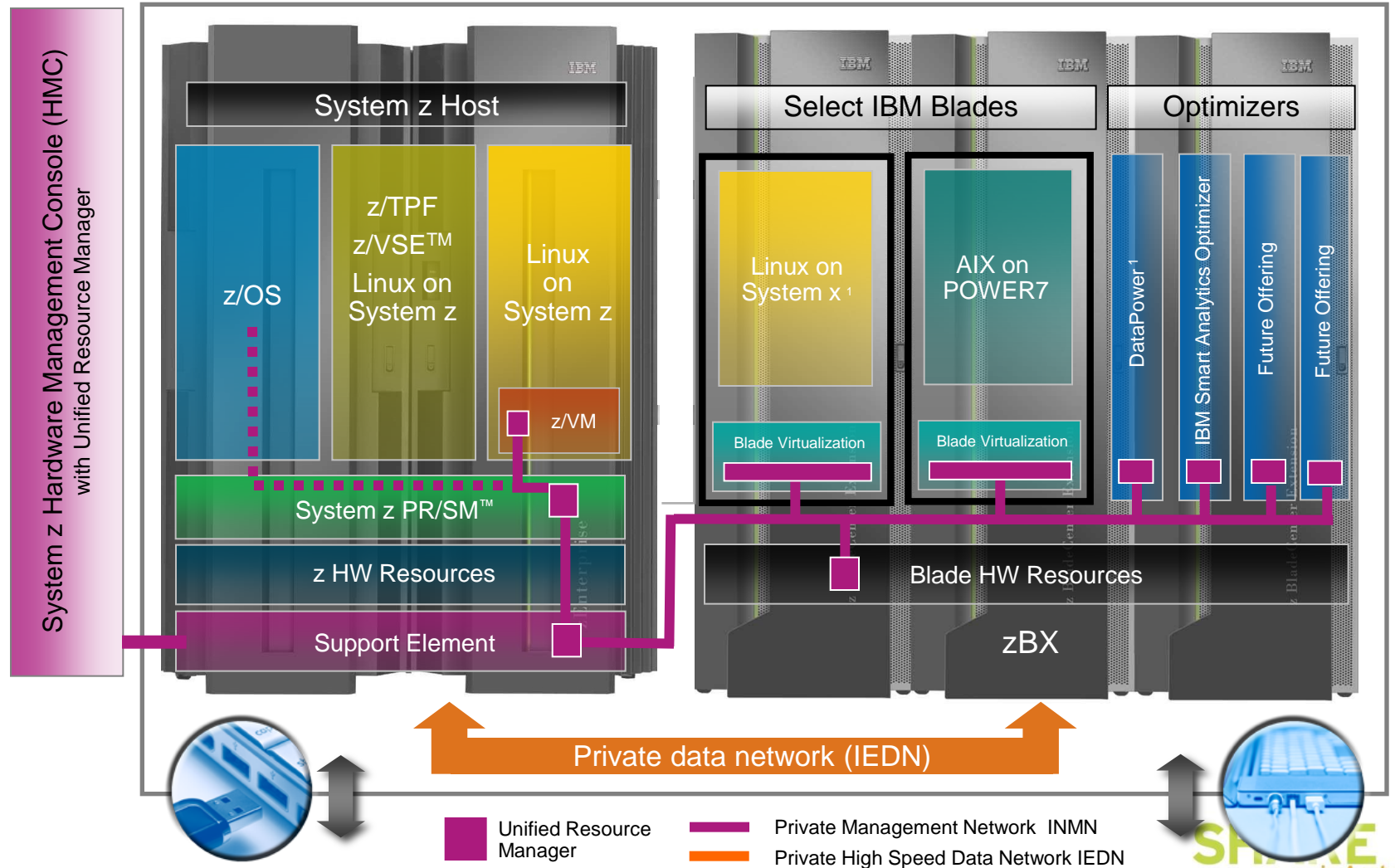

¹ All statements regarding IBM future direction and intent are subject to change or withdrawal without notice, and represents goals and objectives only.